

Fuji pick and place

Nozzles & consumables
Feeders, spares & service
Equipment spares



NOZZLES

NOZZLES FOR FUJI NXT

Nozzles for Heads
H01, H04, H04S, H08/H12,
H08M and H24



PAGES 4-7

NOZZLES FOR NXT OF HEAD

NEW

PAGE 8

NOZZLES FOR NXT DX DYNAHEAD S1 / R4

NEW

PAGE 9

NOZZLES FOR FUJI CP

Premium Nozzles for CP4
and CP6 series SMD inserters



PAGE 10

CUSTOM NOZZLES

Count On Tools

Custom nozzles for
special applications, e.g.
picking and placing LEDs.

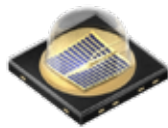

PAGE 11

FEEDERS

HOVER-DAVIS AXIUM MEDIA PRESENTER

Reduce cost, improve quality
and eliminate hand assembly.
Pick and place adhesive
backed media.



PAGES 12-13

HOVER-DAVIS LABEL PRESENTER TO AXIUM MEDIA PRESENTER UPGRADE

Upgrade your fixed label size Label Presenter to
configurable AXIUM Media Presenter

NEW

PAGE 14

FEEDERS FOR NXT AND CP-6

New or overhauled FUJI Feeders,
Feeder-Spares, Carts



PAGE 15

FEEDER-SERVICE

Service for FUJI Feeders
at low fixed rates.

NEW

PAGE 15

HOVER-DAVIS

FEEDERS FOR FUJI

DDF INNOVA DIRECT DIE FEEDER

NXT

Turn a chip shooter into a Flip Chip Shooter, a SMT machine into an advanced semiconductor assembly solution and a custom automation platform into a flexible semiconductor assembly solution. By utilizing DDF technology, customers may realize significant savings by:

- Eliminating separate and dedicated production lines for SMT, bare die and flip chip by combining them into one.
- Enabling total assembly solutions with much higher speed and flexibility, resulting in lower cost per placement.
- Eliminating costly, non-value added processes, such as intermediate die transfer into pocketed tape, surf-tape or waffle packs prior to placement.

Please **ask for a quote**.

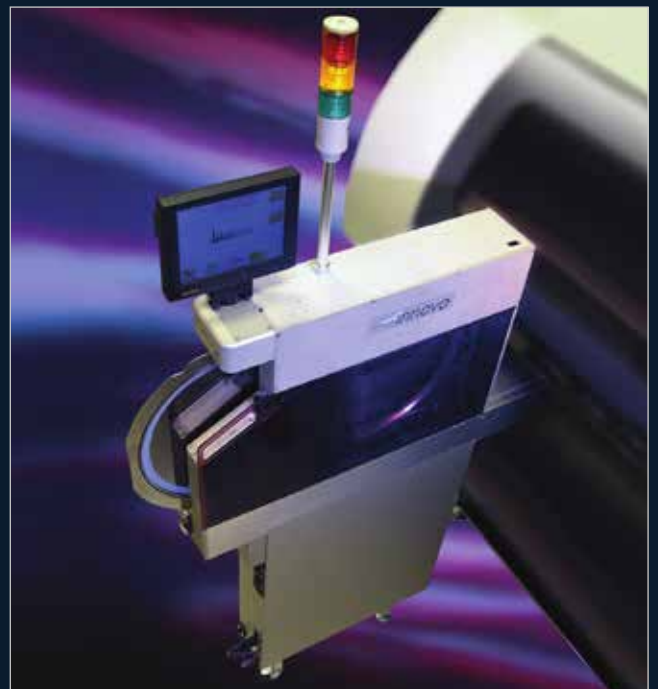

SPARES/CONSUMABLES

NXT FILTERS AND CONSUMABLES

Standard NXT head filters. Original New consumables as specified by Fuji for NXT machines



PAGE 16

SPLICE TAPES FOR FUJI

AdoptSMT Premium Double Splice Tapes provide 100% compatibility to Fuji splice detection as used on NXT, NXTII and AIMEX systems.



PAGE 16

DISPENSE NEEDLES FOR FUJI GL

Dispense needles for Fuji GL series dispensers.



PAGE 17

MACHINE & BOARD HANDLING SPARES

Spare parts for Fuji SMD Mounters (incl. NXT) and Board Handling Systems.



PAGE 18

CONDITIONS

OEM ORIGINAL NEW

Original parts from package purchases. Your benefit: Alternative source for original parts.



ADOPTSMT PREMIUM NEW

AdoptSMT branded spare parts and consumables. Your benefit: Price advantage with same or better quality compared to original parts.



ADOPTSMT RENEW

Repair, reuse, refurbish. Pre-owned equipment of all kinds. Service and repair for expensive parts.



CHECK AVAILABILITY ONLINE

Big stock of FUJI Spare parts. Create online request at <http://www.AdoptSMT.com/articles>.



Also widely used for customer specific automation projects and with programming systems

QF SERIES TAPE FEEDERS: MULTIPITCH, 8-120 MM

IP QP2 QP3 XP

Versatile electronic multipitch operation. Less feeder inventory is required compared to traditional fixed pitch feeders. Smooth, motor-driven feeder advance is electronically controlled. This leads to fewer component mispicks. Reverse index tape drive, dramatically reduces component loss during set up. Please ask for a quote. Machine compatibility: Fuji® IP, QP2, QP3, XP and new models using the MFU interface.



AXIUM MEDIA PRESENTER: MORE THAN JUST A LABEL FEEDER.

PAGE 12

IP QP XP NXT

Reduce cost, improve quality and eliminate hand assembly. Pick and place labels, insulators, interconnect, shields, antennas and other adhesive backed media with the configurable AXIUM Media Presenter available for Fuji IP/QP/XP and NXT. Please visit www.AdoptSMT.com/products/axium to learn more.



The Feeder Company

NXT NOZZLES

ORIGINAL NEW AND PREMIUM QUALITY





AdoptSMT Premium NXT nozzles are designed to meet the demands of a modern production environment.

Every nozzle corresponds to the OEM nozzle design and features both the OEM data matrix code and color matrix code for easy identification by the machine. All AdoptSMT Premium NXT nozzles have been tested and are guaranteed to function properly with the original equipment.

Besides of our Premium Quality nozzles we can also supply a wide range of **Original New** NXT nozzles.

For **special head nozzles** or **special LED and Gripper Nozzles** see **Count On Tools nozzles on page 11**. For nozzles not mentioned please contact our sales team for more information.

NXT NOZZLES H01 HEAD



Articlenumber	Description	EUR/pc		
FU-AA0A500	Nozzle Head H01 ø1.0 NXT, R36-010-260			
FU-AA06800	Nozzle Head H01 ø1.3 NXT, R36-013-260			
FU-AA0MZ00	Nozzle Head H01 ø1.3M/MELF NXT, R36-013M-260			
FU-AA0HL00	Nozzle Head H01 ø1.8 NXT, R36-018-260			
FU-AA11R00	Nozzle Head H01 ø1.8M/MELF NXT, R36-018M-260			
FU-AA0HM00	Nozzle Head H01 ø2.5 NXT, R36-025-260			
FU-AA08410	Nozzle Head H01 ø2.5G NXT with Rubber Pad, R36-025G-260			
FU-AA0ML03	Nozzle Head H01 ø2.5M/MELF NXT, R36-025M-260			
FU-AA0HN00	Nozzle Head H01 ø3.7, R36-037-260			
FU-AA08500	Nozzle Head H01 ø3.7G NXT with Rubber Pad, R36-037G-260			
FU-AA0HR00	Nozzle Head H01 ø5.0 NXT, R36-050-260			
FU-AA07200	Nozzle Head H01 ø5.0G NXT with Rubber Pad, R36-050G-260			
FU-AA08000	Nozzle Head H01 ø7.0 NXT, R36-070-260			
FU-AA07310	Nozzle Head H01 ø7.0G NXT with Rubber Pad, R36-070G-260			
FU-AA08100	Nozzle Head H01 ø10.0 NXT, R36-100-260			
FU-AA07410	Nozzle Head H01 ø10.0G NXT with Rubber Pad, R36-100G-260			
FU-AA08200	Nozzle Head H01 ø15.0 NXT, R36-150-260			
FU-AA07510	Nozzle Head H01 ø15.0G NXT with Rubber Pad, R36-150G-260			
FU-AA08300	Nozzle Head H01 ø20.0 NXT, R36-200-260			
FU-AA07610	Nozzle Head H01 ø20.0G NXT with Rubber Pad, R36-200G-260			

on request

NXT NOZZLES





ORIGINAL NEW AND PREMIUM QUALITY

NXT NOZZLES H04 HEAD

Articlenumber	Description	EUR/pc		
FU-AA06W03	Nozzle Head H04 ø1.0 NXT, R19-010-155			
FU-AA06X04	Nozzle Head H04 ø1.3 NXT, R19-013-155			
FU-AA22Y00	Nozzle Head H04 ø1.3ML/MELF NXT, R19-013M-155			
FU-AA06Y04	Nozzle Head H04 ø1.8 NXT, R19-018-155			
FU-AA22Z00	Nozzle Head H04 ø1.8ML/MELF NXT, R19-018M-155			
FU-AA06Z05	Nozzle Head H04 ø2.5 NXT, R19-025-155			
FU-AA07F02	Nozzle Head H04 ø2.5G NXT with Rubber Pad, R19-025G-155			
FU-AA2KE00	Nozzle Head H04 ø2.5ML/MELF NXT, R19-025M-155			
FU-AA07A05	Nozzle Head H04 ø3.7 NXT, R19-037-155			
FU-AA07G03	Nozzle Head H04 ø3.7G NXT with Rubber Pad, R19-037G-155			
FU-AA07B04	Nozzle Head H04 ø5.0 NXT, R19-050-155			
FU-AA07H03	Nozzle Head H04 ø5.0G NXT with Rubber Pad, R19-050G-155			
FU-AA07C04	Nozzle Head H04 ø7.0 NXT, R19-070-155			
FU-AA07K04	Nozzle Head H04 ø7.0G NXT with Rubber Pad, R19-070G-155			
FU-AA07D03	Nozzle Head H04 ø10.0 NXT, R19-x100x-155			
FU-AA07L04	Nozzle Head H04 ø10.0G NXT with Rubber Pad, R19-100G-155			
FU-AA07E03	Nozzle Head H04 ø15.0 NXT, R19-150-155			
FU-AA07M04	Nozzle Head H04 ø15.0G NXT with Rubber Pad, R19-150G-155			

on request

NXT NOZZLES H04S HEAD

Articlenumber	Description	EUR/pc		
FU-AA8WT00	Nozzle Head H04S ø1.0 NXT			
FU-AA8TE00	Nozzle Head H04S ø1.3 NXT			
FU-AA8WW00	Nozzle Head H04S ø1.8 NXT			
FU-AA8WX00	Nozzle Head H04S ø2.5 NXT			
FU-AA8XA00	Nozzle Head H04S ø2.5G NXT with Rubber Pad			
FU-AA93W00	Nozzle Head H04S ø3.7 NXT			
FU-AA8XB00	Nozzle Head H04S ø3.7G NXT with Rubber Pad			
FU-AA93X00	Nozzle Head H04S ø5.0 NXT			
FU-AA8XC00	Nozzle Head H04S ø5.0G NXT with Rubber Pad			
FU-AA93Y00	Nozzle Head H04S ø7.0 NXT			
FU-AA8XD00	Nozzle Head H04S ø7.0G NXT with Rubber Pad			
FU-AA8WY00	Nozzle Head H04S ø10.0 NXT			
FU-AA8XE00	Nozzle Head H04S ø10.0G NXT with Rubber Pad			
FU-AA8WZ00	Nozzle Head H04S ø15.0 NXT			
FU-AA8XF00	Nozzle Head H04S ø15.0G NXT with Rubber Pad			



on request

NXT NOZZLES

ORIGINAL NEW AND PREMIUM QUALITY

NXT NOZZLES H08/H12 HEAD

New: wide range nozzles

Articlenumber	Description	EUR/pc		
FU-AA1AT10	Nozzle Head H08 ø0.3 NXT, R07-003-070		on request	on request
FU-AA05600	Nozzle Head H08 ø0.4 NXT, R07-004-070			
FU-2AGKNG021600	Nozzle Head H08 ø0.6 NXT, wide range S, R07-006WRS-070		-	
FU-AA05700	Nozzle Head H08 ø0.7 NXT, R07-007-070		on request	
FU-2AGKNG009700	Nozzle Head H08 ø0.8 NXT, R07-008-070		-	
FU-AA05800	Nozzle Head H08 ø1.0 NXT, R07-010-070		on request	
FU-2AGKNG021700	Nozzle Head H08 ø1.1 NXT, wide range M, R07-011WRM-070		-	
FU-AA20A00	Nozzle Head H08 ø1.3 NXT, R07-013-070		on request	
FU-AA06400	Nozzle Head H08 ø1.3/MELF NXT, R07-013M-070			
FU-AA20B00	Nozzle Head H08 ø1.8 NXT, R07-018-070			
FU-AA19G00	Nozzle Head H08 ø1.8/MELF NXT, R07-018M-070		-	
FU-2AGKNG021800	Nozzle Head H08 ø1.8 NXT, wide range L, R07-011WRL-070			
FU-AA20C00	Nozzle Head H08 ø2.5 NXT, R07-025-070			
FU-AA0WT00	Nozzle Head H08 ø2.5G NXT with Rubber Pad, R07-025G-070		on request	
FU-AA06500	Nozzle Head H08 ø2.5/MELF NXT, R07-025M-070			
FU-AA20D00	Nozzle Head H08 ø3.7 NXT, R07-037-070			
FU-AA18C10	Nozzle Head H08 ø3.7G NXT with Rubber Pad, R07-037G-070			
FU-AA20E00	Nozzle Head H08 ø5.0 NXT, R07-050-070			
FU-AA06300	Nozzle Head H08 ø5.0G NXT with Rubber Pad, R07-050G-070			

NXT NOZZLES H08M HEAD

Articlenumber	Description	EUR/pc		
FU-AA8L500	Nozzle Head H08M ø0.4 NXT, R19-004-155-M		on request	
FU-AA8DX00	Nozzle Head H08M ø0.7 NXT, R19-007-155-M			
FU-AA8LT00	Nozzle Head H08M ø1.0 NXT, R19-010-155-M			
FU-AA8DY00	Nozzle Head H08M ø1.3 NXT, R19-013-155-M			
FU-AA8MN00	Nozzle Head H08M ø1.3 Melf NXT, R19-013M-155-M			
FU-AA8LW00	Nozzle Head H08M ø1.8 NXT, R19-018-155-M			
FU-AA8MR00	Nozzle Head H08M ø1.8 Melf NXT, R19-018M-155-M			
FU-AA8LX00	Nozzle Head H08M ø2.5 NXT, R19-025-155-M			
FU-AA8ME00	Nozzle Head H08M ø2.5G NXT with Rubber Pad, R19-025G-155-M			
FU-AA8MS00	Nozzle Head H08M ø2.5 Melf NXT, R19-025M-155-M			
FU-AA8LY00	Nozzle Head H08M ø3.7 NXT, R19-037-155-M			
FU-AA8MF00	Nozzle Head H08M ø3.7G NXT with Rubber Pad, R19-037G-155-M			
FU-AA8LZ00	Nozzle Head H08M ø5.0 NXT, R19-050-155-M			
FU-AA8MG00	Nozzle Head H08M ø5.0G NXT with Rubber Pad, R19-050G-155-M			
FU-AA8MA00	Nozzle Head H08M ø7.0 NXT, R19-070-155-M			
FU-AA8MH00	Nozzle Head H08M ø7.0G NXT with Rubber Pad, R19-070G-155-M			
FU-AA8MB00	Nozzle Head H08M ø10.0 NXT, R19-100-155-M			
FU-AA8MK00	Nozzle Head H08M ø10.0G NXT with Rubber Pad, R19-100G-155-M			
FU-AA8MC00	Nozzle Head H08M ø15.0 NXT, R19-150-155-M			
FU-AA8ML00	Nozzle Head H08M ø15.0G NXT with Rubber Pad, R19-150G-155-M			
FU-AA8MD00	Nozzle Head H08M ø20.0 NXT, R19-200-155-M			
FU-AA8MM00	Nozzle Head H08M ø20.0G NXT with Rubber Pad, R19-200G-155-M			

NXT NOZZLES

ORIGINAL NEW

NXT NOZZLES H24 HEAD

New: wide range nozzles

Articlenumber	Description	EUR/pc	
FU-2AGKNX005100	NOZZLE Head H24 ø0.2 NXT, R047-002-035		on request
FU-2AGKNX005200	NOZZLE Head H24 ø0.3 NXT, R047-003-035		
FU-2AGKNX005300	NOZZLE Head H24 ø0.35 NXT		
FU-2AGKNX005400	NOZZLE Head H24 ø0.4 NXT, R047-004-035		
FU-2AGKNX005500	NOZZLE Head H24 ø0.5 NXT, R047-005-035		
FU-2AGKNX007500	NOZZLE Head H24 ø0.6 NXT wide range S, R047-006WRS-035		
FU-2AGKNX003100	NOZZLE Head H24 ø0.7 NXT, R047-007-035		
FU-2AGKNX006300	NOZZLE Head H24 ø0.8 NXT, R047-008-035		
FU-2AGKNX003500	NOZZLE Head H24 ø1.0 NXT, R047-010-035		
FU-2AGKNX007600	NOZZLE Head H24 ø1.1 NXT wide range M, R047-011WRM-035		
FU-2AGKNX001700	NOZZLE Head H24 ø1.3 NXT, R047-013-035		
FU-2AGKNX004000	NOZZLE Head H24 ø1.3 Melf NXT, R047-013M-035		
FU-2AGKNX003700	NOZZLE Head H24 ø1.8 NXT, R047-018-035		
FU-2AGKNX004100	NOZZLE Head H24 ø1.8 Melf NXT, R047-018M-035		
FU-2AGKNX007700	NOZZLE Head H24 ø1.8 NXT wide range L, R047-018WRL-035		
FU-2AGKNX003900	NOZZLE Head H24 ø2.5 NXT, R047-025-035		
FU-2AGKNX001400	NOZZLE Head H24 ø2.5G NXT, with Rubber Pad, R047-025G-035		
FU-2AGKNX004200	NOZZLE Head H24 ø2.5 Melf NXT, R047-025M-035		

NOZZLES FOR NXT OF HEAD

ORIGINAL NEW

NOZZLES FOR NXT OF HEAD

NEW

Articlenumber	Description	EUR/pc	
FU-AA1CB00	NOZZLE OF Head ø1.0, R26-010-280		on request
FU-AA1CC00	NOZZLE OF Head ø1.3, R26-013-280		
FU-AA1CD00	NOZZLE OF Head ø1.8, R26-018-280		
FU-AA1CE00	NOZZLE OF Head ø2.5, R26-025-280		
FU-AA1CN00	NOZZLE OF Head ø2.5 with Rubber Pad, R26-025G-280		
FU-AA1CF00	NOZZLE OF Head ø3.7, R-26-037-280		
FU-AA1CR00	NOZZLE OF Head ø3.7 with Rubber Pad, R26-037G-280		
FU-AA1CG00	NOZZLE OF Head ø5.0, , R26-050-280		
FU-AA1CS00	NOZZLE OF Head ø5.0 with Rubber Pad, R26-050G-280		
FU-AA1CH00	NOZZLE OF Head ø7.0, R26-070-280		
FU-AA1CT00	NOZZLE OF Head ø7.0 with Rubber Pad, R26-070G-280		
FU-AA1CK00	NOZZLE OF Head ø10.0, R26-100-280		
FU-AA1CW00	NOZZLE OF Head ø10.0 with Rubber Pad, R26-100G-280		
FU-AA1CL00	NOZZLE OF Head ø15.0, R26-150-280		
FU-AA1CX00	NOZZLE OF Head ø15.0 with Rubber Pad, R26-150G-280		
FU-AA1CM00	NOZZLE OF Head ø20.0, R26-200-280		
FU-AA1CY00	NOZZLE OF Head ø20.0 with Rubber Pad, R26-200G-280		

NOZZLES FOR NXT DX DYNAHEAD S1 / R4

ORIGINAL NEW

NOZZLES FOR NXT DX DYNAHEAD S1

NEW

Articlenumber	Description	EUR/pc	
FU-2AGKNL018700	DX Nozzle S1 ø1.3M Melf, DX-S1, LS4, R28-013M-365-F		on request
FU-2AGKNL018800	DX Nozzle S1 ø1.8M Melf, DX-S1, LS5, R28-018M-365-F		
FU-2AGKNL018900	DX Nozzle S1 ø2.5M Melf, DX-S1, LS6, R28-025M-365-F		
FU-2AGKNL018000	DX Nozzle S1 ø2.5G with Rubber Pad, DX-S1, LP6, R28-025G-365-F		
FU-2AGKNL018100	DX Nozzle S1 ø3.7G with Rubber Pad, DX-S1, LP7, R28-037G-365-F		
FU-2AGKNL018200	DX Nozzle S1 ø3.7G with Rubber Pad, DX-S1, LP7, R28-037G-365-F		
FU-2AGKNL018300	DX Nozzle S1 ø7.0G with Rubber Pad, DX-S1, LP9, R28-070G-365-F		
FU-2AGKNL018400	DX Nozzle S1 ø10.0G with Rubber Pad, DX-S1, LP0, R28-100G-365-F		
FU-2AGKNL018500	DX Nozzle S1 ø15.0G with Rubber Pad, DX-S1, LR1, R28-150G-365-F		
FU-2AGKNL018600	DX Nozzle S1 ø20.0G with Rubber Pad, DX-S1, LR2, R28-200G-365-F		

NOZZLES FOR NXT DX DYNAHEAD R4

NEW

Articlenumber	Description	EUR/pc	
FU-2AGKNM000200	DX Nozzle R4 ø1.0, R19-010-095		on request
FU-2AGKNM000300	DX Nozzle R4 ø1.3, R19-013-095		
FU-2AGKNM001700	DX Nozzle R4 1.3M Melf, YH4, R19-013M-095		
FU-2AGKNM000400	DX Nozzle R4 ø1.8, R19-018-095		
FU-2AGKNM001800	DX Nozzle R4 1.8M Melf, YH5, R19-018M-095		
FU-2AGKNM000500	Nozzle R4 ø2.5, R19-025-095		
FU-2AGKNM001900	DX Nozzle R4 2.5M Melf, YH6, R19-025M-095		
FU-2AGKNM001100	DX Nozzle R4 ø2.5G with rubber pad, YE6, R19-025G-095		
FU-2AGKNM000600	DX Nozzle R4 ø3.7, R19-037-095		
FU-2AGKNM001200	DX Nozzle R4 ø3.7G with rubber pad, YE7, R19-037G-095		
FU-2AGKNM000700	DX Nozzle R4 ø5.0, R19-050-095		
FU-2AGKNM001300	DX Nozzle R4 ø5.0G with rubber pad, YE8, R19-050G-095		
FU-2AGKNM000800	DX Nozzle R4 ø7.0, R19-070-095		
FU-2AGKNM001400	DX Nozzle R4 ø7.0G with rubber pad, YE9, R19-070G-095		
FU-2AGKNM000900	DX Nozzle R4 ø10.0, R19-100-095		
FU-2AGKNM001500	DX Nozzle R4 ø10.0G with rubber pad, YF0, R19-100G-095		

NOZZLES FOR CP MACHINES

PREMIUM NOZZLES FOR CP4 AND CP6 SERIES SMD INSERTERS

Additional nozzles or nozzles for CP7, CP8, XP or QP series available upon request.



NOZZLES FOR CP MACHINES

Articlenumber	Description	EUR/pc	
FU-AMPH8710	Nozzle assy fluorescent 0.7		on request
FU-AMPH8720	Nozzle assy fluorescent 1.0		
FU-AMPH8730	Nozzle assy fluorescent 1.3		
FU-AMPH8740	Nozzle assy fluorescent 1.8		
FU-AMPH8750	Nozzle assy fluorescent 2.5 M		
FU-AMPH8760	Nozzle assy fluorescent 2.5 L		
FU-AMPH8770	Nozzle assy fluorescent 3.7 L		
FU-AMPH8780	Nozzle assy fluorescent 5.0 L		
FU-AWPH9510	Nozzle assy FL SS 0.7 R12-007		
FU-AWPH9520	Nozzle assy FL S 1.0 R12-010		
FU-AWPH9530	Nozzle assy FL M 1.3 R12-013		
FU-AWPH9540	Nozzle assy FL M 1.3 M12-013 MELF		
FU-AWPH9550	Nozzle assy FL M 1.8 R12-018		
FU-AWPH9560	Nozzle assy FL L 2.5 R16-025		
FU-AWPH9570	Nozzle assy FL L 3.7 R16-037		
FU-AWPH9580	Nozzle assy FL L 2.5 R20-025		
FU-AWPH9590	Nozzle assy FL 2.5 M20-025 MELF		
FU-AWPH9600	Nozzle assy FL L 2.5 R16-025		
FU-AWPH9610	Nozzle assy FL 5.0 S20-050 FLUOR.		
FU-AWPH9660	Nozzle assy FL 5.0 S22-050 FLUOR.		
FU-AWPH9670	Nozzle assy BLACK 5.0 B22-050		
FU-AWPH9680	Nozzle assy FL 7.0 S22-070 FLUOR.		
FU-AWPH9690	Nozzle assy black 7.0 B22-070		
FU-AWPH9700	Nozzle assy FL SS 0.4 R12-004 (L=6.5)		



COUNT ON TOOLS NOZZLES

SPECIAL APPLICATION CUSTOM NOZZLES
NOZZLES FOR FUJI IP-3, QP, XP

Learn more about AdoptSMTs Count On Tools offerings at
www.AdoptSMT.com/products/countontools

SPECIAL APPLICATION CUSTOM NOZZLES



Articlenumber	Description	EUR/pc	
	Please send us your request mentioning <ul style="list-style-type: none">• machine manufacturer and type• head type• data sheet of items to pick and place, e.g. LED		on request

NOZZLES FOR FUJI IP-3, QP, XP



Articlenumber	Description	EUR/pc	
	Please send us your request mentioning the Fuji part number you need.		on request

AUTO-APPLYING LABELS

HOVER-DAVIS AXIUM MEDIA PRESENTER FOR FUJI: MORE THAN JUST A LABEL FEEDER



HOVER-DAVIS
The Feeder Company



AdoptSMT recommends labels and masking products from CCL (previously Nortec Group). CCL provides labels appropriate to the standards needed for the use with Hover-Davis auto apply processes. More information: www.adoptsmt.com/products/identification

Reduce cost, improve quality and eliminate hand assembly. Pick and place labels, insulators, interconnect, shields, antennas and other **adhesive backed media** with the configurable AXIUM Media Presenter. It automatically feeds and peels media from liner and presents for pick-up.

One for (almost) all

Most applications with media size 3x3 to 42x35mm (width x length) can be handled with ONE Generic Media Platform and can be picked with standard nozzles.

Customer configurations available for < 3mm applications. Platform for up to 58x50mm (width x length) also available.

Plug-and-Play at several speeds

Selectable speed modes for optimal performance. Plug-and-Play models for most platforms and automation cells.

Investment protection

Label feeder LMG modules are compatible with the AXIUM Media Presenter.

Easy handling

Easy to use user interface with push button controls. User serviceable modular design.















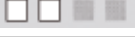



Warranty

Comprehensive 2-year warranty.

HOVER-DAVIS AXIUM FEEDER SPECIFICATIONS				
Specification	Models for 3-42 mm liner width		Models for 14-58 mm liner width	
	Minimum	Maximum	Minimum	Maximum
Media size	3x3 mm* (WxL)	42x50 mm (WxL)	3x3 mm* (WxL)	58x50 mm (WxL)
Media thickness	0.1 mm	0.4 mm	0.1 mm	0.4 mm
Liner Width	3 mm	42 mm	14 mm	58 mm
Liner Thickness	0.05 mm	0.08 mm**	0.05 mm	0.08 mm**
Feed rate	30 mm/sec	95 mm/sec	30 mm/sec	95 mm/sec

* Custom configurations to support media <3mm quoted upon application review. ** Media sample review by Hover-Davis suggested for liner thickness > 0.08mm.

AXIUM MEDIA PRESENTER for 3-42 mm and 14-58 mm liner width				
Pick and place machine compatible with	Description	Art No. Original New	EUR/Pc	Comp. Modules
FOR 3-42 MM LINER WIDTH				
NXT, I, II, III, AIM, AIMEX, XPF	AXIUM Media Presenter Fuji NXT	HO-AMPFN02-001	on request	GMP02, GMP01 ⁽⁷⁾ , LMG02
	AXIUM Media Presenter Fuji NXT with Reel Holder	HO-AMPFN02-002		
FOR 14-58 MM LINER WIDTH				
NXT, I, II, III, AIM, AIMEX, XPF	AXIUM Media Presenter Fuji NXT	HO-AMPFN12-001	on request	GMP12, GMP11 ⁽⁷⁾ , LMG12
	AXIUM Media Presenter Fuji NXT with Reel Holder	HO-AMPFN12-002		
GENERIC MEDIA PLATFORM (MODULE)		FOR 3-42 MM LINER WIDTH	FOR 14-58 MM LINER WIDTH	
GMP35 Generic Media Plattform adjustable module, supports 3 - 35mm label length (Standard)		HO-GMP02	on request	HO-GMP12
GMP50 Generic Media Plattform, adjustable module, supports 3 - 50mm label length (special applications)		HO-GMP01		HO-GMP11
Custom Label Module – Special Applications, Custom Module - Requires Application Review, 4 mm minimum label length		HO-LMG02..	on request	HO-LMG12..
(7) Application Dependent - consult AdoptSMT for GMP01/GMP11 module compatibility.				

HOVER-DAVIS AXIUM MEDIA RECOMMENDATIONS				
Property	Recommended		Not recommended	
Label size		Min 3x3mm, max 42x50 mm (wide: 58x50 mm), width x length		Less than 3x3 mm, more than 42x50 mm (wide: 58x50 mm)
Label shape		Rectangle, square, round		Irregular Shapes (with and without cutouts) Talk to us. We can test and make work many irregular shapes.
Die cut		No lift marks		Prominent lift marks
Label opacity		Opaque to semi-transparent		Transparent media
Pitch		Minimum 1 mm required		Less than 1 mm
Single column		Single column is ideal		Multi-column – Some machine applications are not compatible with multiple columns
Label orientation		crosswise		lengthwise
Cover tape		None		Additional insulating tape not removable by presenter
Reel size		3 inches ID required		Other than 3 inches
Reel winding direction		Overhand, media facing up (out)		Underhand, media facing down (in)



HOVER-DAVIS AXIUM 'RAMP'

TURN YOUR FIXED LABEL SIZE HOVER-DAVIS LP-FEEDER INTO A FLEXIBLE LABEL SIZE AXIUM MEDIA PRESENTER



Back: LP Feeder with fixed label size LMG label module
 Front: LP Feeder upgraded to a RAMP Axium Media Presenter with flexible label size GMP module

SAME AS AXIUM 'AMP' – FOR LESS MONEY

All features of Hover-Davis AXIUM apply.

SEVERAL UPGRADE PATHS

- upgrade your own LP Feeder to AXIUM 'RAMP'
- get new 'RAMP' and return your LP Feeder for credit
- get 'RAMP' instead of AXIUM 'AMP' and save costs (subject to availability)

INVESTMENT PROTECTION

Label feeder LMG modules are compatible with the AXIUM Media Presenter.

EASY HANDLING

Easy to use user interface with push button controls. User serviceable modular design.

WARRANTY

Comprehensive 1-year warranty for all kinds of upgrade paths.

Articlenumber	Description	EUR/pc	
Upgrade your Hover-Davis LP label presenter (complete and running) to AXIUM Media Presenter:			
HO-RAMPFN02-001REP	Upgrade LPFN02-001 to AXIUM AMPFN02-001 Media Presenter		on request
HO-RAMPFN02-002REP	Upgrade LPFN02-002 to AXIUM AMPFN02-002 Media Presenter		
Get new 'RAMP' AXIUM Media Presenter (rebuilt LP-Feeder):			
HO-RAMPFN02-001	AXIUM AMPFN02-001 Media Presenter (rebuilt LP-Feeder), FUJI NXT		on request
	Optional credit for return of used but complete and fully functional LPFN02-001		
HO-RAMPFN02-002	AXIUM AMPFN02-002 Media Presenter (rebuilt LP-Feeder), FUJI, with Reel Holder		
	Optional credit for return of used but complete and fully functional LPFN02-002		
Generic Media Platform (Module) for flexible label sizes:		see page 13	
The following only applies to LP Feeders with serial numbers below xxxx xxxx 0710:			
Upgrade of metal toothed wheel to plastic toothed wheel including new motor for LP feeder			on request

FEEDERS FOR NXT

ORIGINAL NEW, OVERHAULED OR TESTED, FEEDER SERVICE



FEEDERS

Articlenumber	Feeder intelligent, w/o reel holder	For NXT version	ORIGINAL		RENEW					
			Product Price EUR/pc		Service Price EUR/pc					
			Original New	overh. or tested	Service starting at	Repair max.				
FU-UF09900	W08C	NXT II	on request							
FU-UF10200	W12C									
FU-UF10400	W16C									
FU-2UDLFA001200	W08F	NXT III								
FU-2UDLFB001100	W12F									
FU-2UDLFB001300	W16F									
FU-2UDLFB001400	W24F									
FU-UF10600	W24C	NXT II + III								
FU-UF10800	W32C									
FU-UF11000	W44C									
FU-UF11200	W56C									
FU-UF05200	W72									
FU-UF05300	W88									
Feeders for Fuji CP-6 on stock							on request			

FEEDER SPARE PARTS

Spare parts for NXT, CP/QP/IP feeder service. Additional Feeder parts, also for other feeder types, available upon request.

Articlenumber	Description
Please check availability of about 5000 FUJI parts on www.adoptsmt.com/articles	

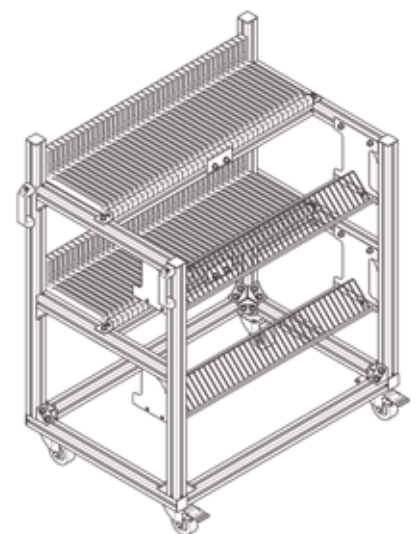

FEEDER STORAGE CARTS



NEW

Articlenumber	Description	EUR/pc	PREMIUM
AD-FC-NXT	Feeder storage cart for Fuji NXT feeders, 2 layers, 880(L) x 600(W) x 1200(H) mm		on request
AD-FC-NXT-ESD	Same as above, ESD compliant		

NXT FILTERS

ORIGINAL NEW AND PREMIUM QUALITY



Articlenumber	Description	EUR/pc		
FU-XH00560	Filter XT/H01 (ø5x12.4mm)		on request	
FU-XH00940	Filter NXT/H01 (ø4x8.3mm)			
FU-XH00400	Filter NXT/H04+H08 (6.0mm)			
FU-AA0A100	Filter assy NXT/Head H04+H08			
FU-XH00800	Filter NXT/H12+V12 (4.5mm)			
FU-AA19H02	Filter assy NXT/Head H12+H12S			
FU-2MGTHA067900	Filter NXT Head H24			

SPLICE TAPES FOR FUJI

See our full range of splicing products in our catalog:
www.AdoptSMT.com/#SectionLibrary

AdoptSMT Premium Double Splice Tapes do not require any additional tools to be used and provide 100% compatibility to Fuji splice detection as used on NXT, NXTII and AIMEX systems.



Tape (mm)	Pcs/ Pack	Articlenumber	Description	EUR/pc	
4	500	AD-SPL-D-4-500FS	4 mm FUJI Double Splice Tape, silver		on request
8	500	AD-SPL-D-8-500FS	8 mm FUJI Double Splice Tape, silver		
12	500	AD-SPL-D-12-500FS	12 mm FUJI Double Splice Tape, silver		
16	500	AD-SPL-D-16-500FS	16 mm FUJI Double Splice Tape, silver		
24	250	AD-SPL-D-24-250FS	24 mm FUJI Double Splice Tape, silver		

CONSUMABLES FOR FUJI

Original New consumables as specified by Fuji for NXT machines, but usable for other machines as well.



Articlenumber	Description	EUR/pc	
FU-H5116A	Rust Inhibitor Biral Spray T&D (500ml)		on request
FU-K3035K	Grease NS7 (80g Tube)		
FU-K3035Z	Grease AFB-Grease (70g)		
FU-K3036C	Grease AFC-Grease for MG-70 (70g)		
FU-H1021E	Battery ER6-VC4		



DISPENSE NEEDLES FOR FUJI GL

Dispense needles for Fuji GL series dispensers.
 Additional needles can be manufactured upon request.
 Please inform us about your requirements.

Articlenumber	Description	EUR/pc	
FU-AHRG011312	Needle single (special) \varnothing 1.3mm/0.9mm/G 1.2mm		on request
FU-AHRG0670	Needle twin \varnothing 0.4mm/SS 0.5mm/G 0.1mm		
FU-AHRG0690	Needle single \varnothing 0.5mm/SS 0.5mm/G 0.2mm		
FU-AHRG0700	Needle single \varnothing 0.6mm/SS 0.5mm/G 0.3mm		
FU-AHRG0850	Needle twin \varnothing 0.4mm/TS 1.3mm/G 0.1mm		
FU-AHRG1320	Needle twin \varnothing 0.5mm/TS 1.3mm/G 0.1mm		
FU-AHRG1330	Needle single \varnothing 0.6mm/SS 0.7mm/G 0.3mm		
FU-AHRG1350	Needle single \varnothing 0.7mm/SS 0.7mm/G 0.4mm		
FU-AJRG0830	Needle twin \varnothing 0.3mm/SS 1.0mm/G 0.1mm		

MACHINE AND BOARD HANDLING SPARE PARTS



Spare parts for Fuji SMD Mounters (incl. NXT) and Board Handling Systems. Additional parts available upon request! We also have lots of Original Fuji parts in stock. Please let us know your requirements.

Articlenumber	Description	EUR/pc		
FU-2SGTHA000500	Syringe	-	-	-
FU-2AGKGG000600	Cover	-	-	-
FU-A1042T	Amplifier HPX-T1	-	-	on request
FU-A5054X	O-Ring No.13 (NXT for XS01180)	-	-	-
FU-ADBPP8010 *)	Pulley assy	-	-	-
FU-AMQC1061	Pulley	-	-	-
FU-AMQC1292	Pulley	-	-	-
FU-CLC4400	Belt L=2255 for CAC-4100B	on request	-	-
FU-CLC9390	Belt L=1455 (CACE4180B/4120B/4060B)	-	-	-
FU-CSQC0700	Belt L=2590 CP643E/IN-conveyor	-	-	-
FU-H3005W *)	Fiber unit FU-35FA	-	-	-
FU-H4104A *)	Bearing DDA-2520	-	-	-
FU-H4202Z *)	Bearing 6900ZZ	-	-	-
FU-H4445A *)	Miniature bearing DDLF-1050ZZ	-	-	on request
FU-H5448D	Vacuum pump maintenance kit for DOP-300SA(XP00530)	-	-	-
FU-H5448E	Vacuum pump maintenance kit for DOP-420SA (XP01600)	-	-	-
FU-K1112A *)	Cam follower CF05UU-A	-	-	-
FU-K5488B *)	Pam parts (for NXT)	-	-	-
FU-MPH3011	2.5 MPH-3011 MPH-3011	on request	-	-
FU-PM03500 *)	Cutter stationary NXT/M6	-	-	-
FU-PM05020 *)	Fixed Cutter M3	-	-	-
FU-PM05030 *)	Cutter movable NXT/M3 TO PT00750	-	-	-
FU-PM40960 *)	Pipe	-	-	-
FU-RH21370 *)	Connection cable Smema Cable (3m)	-	-	on request
FU-S4028H *)	Sensor EX-11A-FJ-PN with slit TO S61582	-	-	-
FU-UH00800 *)	Head Assy without the chuck for auto PCB support p	-	-	-
FU-UL01700 *)	Nozzle Station H01/NC8LA NXT (Option)	-	-	-
FU-WAF6340	Roller	-	-	-
FU-WAF6350	Roller	-	-	-
FU-WPH1160	Spring (for nozzle CP6)	on request	-	-
FU-WPH2030	Folter CP-6 shaft (AWPH3080) 12x10	-	-	-

*) Subject to prior sale

CHECK AVAILABILITY ONLINE FROM OVER 5000 PRODUCTS FOR FUJI

and create your request at www.AdoptSMT.com/articles

The screenshot shows a web browser window with the URL <https://tools.adoptsmt.com/articles/search/>. The page title is "ADOPTSMT PRODUCT SEARCH". A search bar contains "Filter NXT" and a dropdown menu is set to "Fuji". A green "Search" button is visible. On the right side, there is a vertical navigation menu with links for Feeder, Spares, Consumables, Accessories, Tools, Service, and Repairs.

Below the search bar, it states "8 available products found". The results are displayed in a table with columns for Manufacturer, Article Number, Description, Qty/Pack, Original New, Premium New, Renew, and Request. Each row includes an "Add to cart" button.

Manufacturer	Article Number	Description	Qty/Pack	Original New	Premium New	Renew	Request
Fuji	ZMGTHA067900	Filter NXT Head H24	1	on request	available on stock		Add to cart
Fuji	AA0AL00	FILTER ASSY NXT/Head H04+H08	1	available on stock	available on stock		Add to cart
FUJI	AA19H02	FILTER ASSY NXT/Head H12+H12S	1	available on stock	available about 35 days		Add to cart
Fuji	XH00120	Filter Regulator NXT	1		on request		Add to cart
Fuji	XH00400	FILTER NXT/H04+H08 (6.0mm)	1	available on stock	available on stock		Add to cart
Fuji	XH00560	FILTER 4S0-FILTER-FL322717 NXT/H01 (Ø5x12.4mm)	1	available on stock	available on stock		Add to cart
Fuji	XH00800	FILTER NXT/H12+V12 (4.5mm)	1	available on stock	available on stock		Add to cart
Fuji	XH00940	FILTER NXT/H01 (Ø4x8.3mm)	1	available on stock	available about 28 days		Add to cart

LOCATIONS

We are here for you internationally

AdoptSMT Europe
HQ Austria

Untersbergstrasse 1
5082 - Grödig near Salzburg
T: +43 6246 724 400
info@adoptsmt.com

Austria | Germany | Poland | United Kingdom | France | Swiss

adoptsmt.com